

Bus BridgeNet[®]

ADDENDUM

REMOTE CONTROL

(Software version 07.04.07)

1. back button  (previous screen)
2. knob
3. **OK** button (to confirm operation or access main menu)
4. DISPLAY

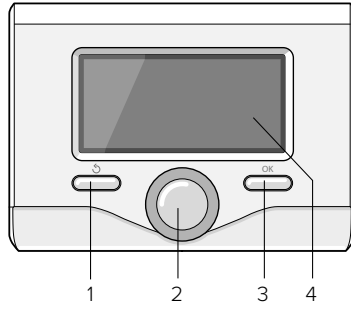

USER MENU



Press the OK button to access the Menu. Use the knob in the centre to scroll through the menu list and select a parameter, then press OK to confirm.

SYSTEM OPERATION MODE	
Summer	OFF
COMPLETE MENU	
DOMESTIC HOT WATER SETTINGS	
DHW comfort setpoint temperature	
Time Programming	
Domestic Hot Water Program	
<ul style="list-style-type: none"> - Set Comfort T - Set Reduced T - Set Time Prog - DHW Pre-heating 	
Auxiliary Timer	
<ul style="list-style-type: none"> - Set Comfort T 	
Comfort function	
<ul style="list-style-type: none"> - Disabled - Time Based - Always Active 	
Thermal cleanse function	
<ul style="list-style-type: none"> - Thermal cleanse function - Thermal Cleanse target temp 	
Operation mode	
<ul style="list-style-type: none"> - Green - Comfort - Fast - I-memory - HC-HP 	
Domestic Hot Water BOOST	
<ul style="list-style-type: none"> - OFF - ON 	
Holiday Function	
<ul style="list-style-type: none"> - OFF - ON 	
SPECIAL MODE	
HPWH Quiet Mode Activation	
<ul style="list-style-type: none"> - OFF - ON 	
PV setpoint temp.	
SYSTEM PERFORMANCES	
Energy Metering	
Consumptions history	
<ul style="list-style-type: none"> - DHW 	
DHW temperature (T dome) (non disponibile)	

TECHNICAL AREA

- Simultaneously press the back “” and “OK” buttons until “Enter code” appears on the display.
- Turn the knob to enter the technical code (234) then press OK; the display will show **TECHNICAL AREA**.
- Turn the knob and select: **COMPLETE MENU**. Press the OK button. Turn the knob and select menu: **33 HPWH Parameters**, press the OK button.

MENU HPWH	MENU	SUB-MENU	PARAMETER	DESCRIPTION	RANGE
	33			HPWH Parameters	
	33	0		User parameters	
MODE	33	0	0	Operation Mode	0. Green 1. Comfort 2. Fast 3. I-memory 4. HC - HP
P16 U8	33	0	1	Quiet Mode	OFF - ON
P15	33	0	2	Acoustic touch feedback	OFF - ON
>>	33	0	3	Domestic hot water boost	OFF - ON
U3.2	33	0	4	DHW preheating	OFF - ON
	33	1		Advanced settings	
P10	33	1	0	Tank capacity	
P6	33	1	1	I - memory comfort temperature	
P8	33	1	2	Min temperature air HP	
P7	33	1	3	Max temperature HP	
P9	33	1	4	Hyst temperature HP	
	33	2		Input output configuration	
P1	33	2	0	HC - HP mode	0. OFF 1. HC - HP 2. HC - HP 40 3. HC - HP 24h
P11	33	2	1	Photovoltaic integration	0. OFF 1. Heat Pump 2. HP + HE1 3. HP + HE1 + HE2
P12	33	2	2	PV setpoint temperature	
P13	33	2	3	SG mode	OFF - ON
	33	3		System settings	
P14	33	3	0	Hydraulic scheme	0. Only HP 1. Auxiliary 2. Preheater 3. HP system
	33	4		Domestic Hot Water	
+ / -	33	4	0	DHW comfort setpoint temp.	
U3.1	33	4	1	DHW reduced setpoint temp.	
P4	33	4	2	Max T	
P5	33	4	3	Min T	
U1	33	4	4	Comfort Function	0. Disabled 1. Time based 2. Always active
P1	33	4	5	Max heating time	
P2 U5	33	4	6	Thermal cleanse function	OFF - ON

MENU HPWH	MENU	SUB-MENU	PARAMETER	DESCRIPTION	RANGE
P3	33	4	7	Thermal Cleanse target temp	
	33	6		Statistics - 1	
	33	6	0	HP running hours (h/10)	
	33	6	1	Resistor 1 running hours (h/10)	
	33	6	2	Resistor 2 running hours (h/10)	
	33	6	3	HP on cycles (n/10)	
	33	6	4	Resistor 1 on cycles (n/10)	
	33	6	5	Resistor 2 on cycles (n/10)	
	33	6	6	Lifetime (h /10)	
	33	7		Statistics - 2	
	33	7	1	Showers n°	
	33	7	3	Heating remaining time	
	33	8		HP diagnostics - 1	
SET	33	8	0	Internal temperature	
	33	8	1	Required temperature	
P23	33	8	2	Dome temperature	
P22	33	8	3	High sensor temperature	
P21	33	8	4	Low sensor temperature	
	33	9		HP diagnostics - 2	
P24	33	9	0	Outside air temperature	
P25	33	9	1	HP Evaporator temp	
P26	33	9	2	HP Suction temp	
P28	33	9	3	HP Discharge temp	
P27	33	9	4	HP condenser outlet temp	
P29	33	9	5	Superheat temperature	
	33	10		HP diagnostics - 3	
ICONE DISPLAY	33	10	0	Status	0. Lockout 1. Idle 2. Heating 3. Thermal cleanse function 4. Antifreeze cycle
HP 	33	10	1	Heat pump mode	0. Not defined 1. Idle 2. Pre fan 3. Heating 4. Post fan 5. Defrost 6. Defrost 7. Air temp out of range 8. Charge mode
HP 	33	10	2	Heating mode	1. OFF 2. Heat Pump 3. HE1 4. HP + HE1 5. HE1 + HE2 6. HE2 7. HP + HE2 8. Auxiliary 9. HP + AUX

MENU HPWH	MENU	SUB-MENU	PARAMETER	DESCRIPTION	RANGE
	33	10	3	PV integration active	OFF - ON
	33	10	4	SG active	OFF - ON
	33	11		HP diagnostics - 4	
	33	11	0	HP actual compressor frequency	
	33	11	1	Fan speed	
	33	11	2	Expansion valve	
	33	11	3	HC - HP input	OFF - ON
	33	11	4	PV - SG input	OFF - ON
	33	12		Error History	
P30	33	12	0	Last 10 errors	
P30	33	12	1	Reset error list	Reset? OK=Yes, esc=No
	33	13		Reset Menu	
P18	33	13	0	Reset factory settings	Reset? OK=Yes, esc=No
U9	33	13	1	Reset i - memory	Reset? OK=Yes, esc=No

COMMANDE À DISTANCE

(Software version 07.04.07)

1. touche Retour  (affichage précédent)
2. bouton
3. touche **OK** (confirmer l'opération ou accéder au menu principal)
4. AFFICHEUR

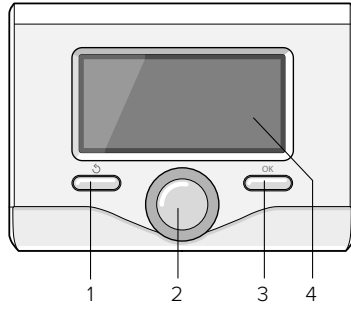

MENU UTILISATEUR



Appuyez sur la touche OK pour accéder au Menu. Utilisez le bouton au centre pour faire dérouler la liste des menus et pour sélectionner les paramètres, appuyez sur la touche OK pour valider.



SYSTEM OPÉRATION MODES	
Eté	OFF
MENU	
RÉGLAGES ECS	
Température COMFORT ECS	
Programmation	
ECS	
- Réglage T° chauffage Confort	
- Réglage T° chauffage Eco	
- Choix programmes prédéfinis	
- ECS Pre-heating	
Timer auxiliaire	
- Réglage T° chauffage Confort	
Fonction COMFORT	
- Désactivée	
- Temporisée	
- Toujours active	
Fonction anti-bactérie	
- Fonction anti-bactérie	
- T° consigne fonction anti-bactérie	
Mode opération	
- Green	
- COMFORT	
- Rapide	
- I-memory	
- Heures creuses -Heures pleines	
Fonction boost ECS	
- OFF	
- ON	
Fonction Vacances	
- OFF	
- ON	
FONCTIONS SPÉCIALES	
Activation mode nuit CETD	
- OFF	
- ON	
PV delta T° ECS	
PERFORMANCE ÉNERGÉTIQUE	
Comptage d'énergie	
Historique des consommations	
- ECS	
DHW temperature (T dome) (non disponible)	

MENU TECHNICIEN

- Appuyez simultanément sur les touches Retour  et "OK" jusqu'à l'affichage de l'option "Insérer code".
- Tournez le bouton pour insérer le code (234). Appuyez sur le bouton OK pour afficher **MENU TECHNICIEN**.
- Tournez le bouton et sélectionnez: **MENU**.
Premere il tasto OK. Tournez le bouton et sélectionnez le menu **33 HPWH Parameters**, appuyez sur la touche OK.

MENU HPWH	MENU	SOUS-MENU	PARAMÈTRE	DESCRIPTION	SÉLECTION
	33			Paramètres CETD	
	33	0		PARAMETRE UTILISATEUR	
MODE	33	0	0	Mode opération	0. Green 1. COMFORT 2. Rapide 3. I-memory 4. Heures creuses - Heures pleines
P16 U8	33	0	1	Mode nuit PAC	OFF - ON
P15	33	0	2	Niveau acoustique	OFF - ON
>>	33	0	3	Fonction boost ECS	OFF - ON
U3.2	33	0	4	Préchauffage ECS	OFF - ON
	33	1		Réglages avancés	
P10	33	1	0	Capacité ballon	
P6	33	1	1	Température confort i - memory	
P8	33	1	2	Température mini air PAC	
P7	33	1	3	Température max PAC	
P9	33	1	4	Hystérésis température PAC	
	33	2		Config. entrée sortie	
P1	33	2	0	Mode HC - HP	0. OFF 1. Heures creuses - Heures pleines 2. Heures creuses - Heures pleines - 40 3. HC - HP 24h
P11	33	2	1	Integration PV	0. OFF 1. Pompe à chaleur 2. PAC + Résistance1 3. PAC + HE1 + HE2
P12	33	2	2	Consigne température PV	
P13	33	2	3	Mode Smart Grid	OFF - ON
	33	3		Réglages du système	
P14	33	3	0	Schéma installation hydraulique	0. PAC seule 1. Auxiliaire 2. Préchauffage 3. Système pompe à chaleur
	33	4		PARAMETRE SANITAIRE	
+ / -	33	4	0	Température COMFORT ECS	
U3.1	33	4	1	Température ECO ECS	
P4	33	4	2	Réglage T° max CH	
P5	33	4	3	Réglage T° min CH	
U1	33	4	4	Fonction COMFORT	0. Désactivée 1. Temporisée 2. Toujours active

MENU HPWH	MENU	SOUS-MENU	PARAMÈTRE	DESCRIPTION	SÉLECTION
P1	33	4	5	Temps maxi chauffe	
P2 U5	33	4	6	Fonction anti-bactérie	OFF - ON
P3	33	4	7	T° consigne fonction anti-bactérie	
	33	6		STATISTIQUE - 1	
	33	6	0	Temps marche PAC [h/10]	
	33	6	1	Heures de travail de la rés. 1 [h/10]	
	33	6	2	Heures de travail de la rés. 2 [h/10]	
	33	6	3	Nombre démarrages PAC [nb/10]	
	33	6	4	Cycles de la résistance 1 [nb/10]	
	33	6	5	Cycles de la résistance 2 [nb/10]	
	33	6	6	Durée de fonctionnement [h /10]	
	33	7		STATISTIQUE - 2	
	33	7	1	Evaluation nb douches disponibles	
	33	7	3	Temps de chauffe restant	
	33	8		DIAGNOSTIC PAC - 1	
SET	33	8	0	Température interne	
	33	8	1	Température désirée	
P23	33	8	2	Température haute	
P22	33	8	3	Sonde température haute	
P21	33	8	4	Sonde température basse	
	33	9		DIAGNOSTIC PAC - 2	
P24	33	9	0	Température air extérieure	
P25	33	9	1	Température évaporation PAC	
P26	33	9	2	Température aspiration PAC	
P28	33	9	3	Température refoulement PAC	
P27	33	9	4	Température sortie condenseur PAC	
P29	33	9	5	Température surchauffe	
	33	10		DIAGNOSTIC PAC - 3	
ICONE DISPLAY	33	10	0	Statut	0. Verrouillage 1. Veille 2. Chauffage 3. Fonction anti-bactérie 4. Hors gel
HP 	33	10	1	Mode PAC	0. Non défini 1. Veille 2. Pre ventilation 3. Chauffage 4. Post ventilation 5. Dégivrage 6. Dégivrage 7. Température d'air hors plage 8. Mode de chauffe

MENU HPWH	MENU	SOUS-MENU	PARAMÈTRE	DESCRIPTION	SÉLECTION
HP 	33	10	2	Mode de chauffage	1. OFF 2. Pompe à chaleur 3. Résistance1 4. PAC + Résistance1 5. Résistance1 + Résistance2 6. Résistance 2 7. PAC + Résistance 2 8. Auxiliary 9. PAC + AUX
	33	10	3	Intégration photovoltaïque active	OFF - ON
			4	Entée smart grid	OFF - ON
	33	11		DIAGNOSTIC PAC - 4	
	33	11	0	Fréquence compresseur PAC	
	33	11	1	Vitesse ventilateur	
	33	11	2	Statut détenteur gaz	
	33	11	3	Entrée HC - HP	OFF - ON
	33	11	4	Entrée PV ou Smart Grid	OFF - ON
	33	12		HISTORIQUE DES ANOMALIES	
P30	33	12	0	10 dernières anomalies	
P30	33	12	1	Reset des anomalies	Si vous appuyez sur le bouton OK, la commande de réinitialisation sera exécutée sinon en appuyant sur la touche ESC, vous retournerez à l'écran précédent.
	33	13		Menu Réinitialisation	
P18	33	13	0	Rétablir réglages usine	Si vous appuyez sur le bouton OK, la commande de réinitialisation sera exécutée sinon en appuyant sur la touche ESC, vous retournerez à l'écran précédent.
U9	33	13	1	Reset i - memory	Si vous appuyez sur le bouton OK, la commande de réinitialisation sera exécutée sinon en appuyant sur la touche ESC, vous retournerez à l'écran précédent.

CONTROLLO REMOTO

(Versione software 07.04.07)

1. tasto indietro  (visualizzazione precedente)
2. manopola
3. tasto **OK** conferma l'operazione o accede al menu principale)
4. DISPLAY

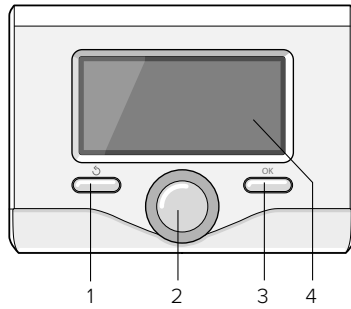

MENU UTENTE

Premere il tasto OK per accedere al Menu. Utilizzare la manopola centrale per lo scorrimento della lista menu e la selezione parametri, premere il tasto OK per confermare.



MODALITÀ OPERATIVE DEL SISTEMA	
Estate	OFF
MENU COMPLETO	
IMPOSTAZIONE ACQUA CALDA	
Temperatura comfort acqua calda	
Programmazione oraria	
Programmazione acqua calda	
<ul style="list-style-type: none"> - Imposta temp. comfort - Imposta temp. ridotta - Imposta programmazione - ACS Pre-heating 	
Timer ausiliario	
<ul style="list-style-type: none"> - Imposta temp. comfort 	
Funzione comfort	
<ul style="list-style-type: none"> - Esclusa - Temporizzata - Sempre attiva 	
Ciclo di sanificazione termica	
<ul style="list-style-type: none"> - Ciclo di sanificazione termica - Temperatura obiettivo del ciclo 	
Modalità operativa	
<ul style="list-style-type: none"> - Green - Comfort - Veloce - I-memory - HC-HP 	
BOOST acqua sanitaria	
<ul style="list-style-type: none"> - OFF - ON 	
Funzione vacanze	
<ul style="list-style-type: none"> - OFF - ON 	
FUNZIONI SPECIALI	
Attivazione modo silenzioso PdC ACS	
<ul style="list-style-type: none"> - OFF - ON 	
Delta temp. setpoint sanit. fotovoltaico	
PRESTAZIONI SISTEMA	
Consumi energetici	
Storico dei consumi	
<ul style="list-style-type: none"> - Acqua sanitaria 	
DHW temperature (T dome) (non disponibile)	

AREA TECNICA

- Premere contemporaneamente i tasti indietro  e "OK" fino alla visualizzazione sul display "Inserimento codice".
- Ruotare la manopola per inserire il codice tecnico (234), premere il tasto OK, il display visualizza **AREA TECNICA**.
- Ruotare la manopola e selezionare: **MENU COMPLETO**. Premere il tasto OK. Ruotare la manopola e selezionare il menu **33 HPWH Parameters**, premere il tasto OK.

MENU HPWH	MENU	SOTTO-MENU	PARAMETRO	DESCRIZIONE	RANGE
	33			Parametri HPWH	
	33	0		Parametri utente	
MODE	33	0	0	Modalità operativa	0. Green 1. Comfort 2. Veloce 3. I-memory 4. HC - HP
P16 U8	33	0	1	Modo silenzioso	OFF - ON
P15	33	0	2	Feedback sonoro dei tasti	OFF - ON
>>	33	0	3	Boost acqua sanitaria	OFF - ON
U3.2	33	0	4	Preriscaldamento acqua sanitaria	OFF - ON
	33	1		Impostazioni avanzate	
P10	33	1	0	Capacità accumulo	
P6	33	1	1	I-memory temperatura di comfort	
P8	33	1	2	Minima temperatura aria PDC	
P7	33	1	3	Max temperatura aria PDC	
P9	33	1	4	Storico temperatura PDC	
	33	2		Configurazione ingressi uscite	
P1	33	2	0	HC - HP mode	0. OFF 1. HC - HP 2. HC - HP 40 3. HC - HP 24h
P11	33	2	1	Integrazione fotovoltaico	0. OFF 1. Pompa di calore 2. PDC + Resistenza 1 3. PDC + Resistenza 1 + Resistenza 2
P12	33	2	2	PV temperatura SetPoint	
P13	33	2	3	Modalità SG	OFF - ON
	33	3		Impostazioni di sistema	
P14	33	3	0	Schema idraulico	0. Solo PdC 1. Ausiliario 2. Preriscaldatore 3. Sistema Pompa di Calore
	33	4		Sanitario	
+ / -	33	4	0	Temperatura comfort acqua calda	
U3.1	33	4	1	Temperatura ridotta acqua calda	
P4	33	4	2	Max T	
P5	33	4	3	Min T	
U1	33	4	4	Funzione Comfort	0. Esclusa 1. Temporizzata 2. Sempre attiva
P1	33	4	5	Tempo massimo di riscaldamento	

MENU HPWH	MENU	SOTTO-MENU	PARAMETRO	DESCRIZIONE	RANGE
P2 U5	33	4	6	Ciclo di sanificazione termica	OFF - ON
P3	33	4	7	Temperatura obiettivo del ciclo	
	33	6		Statistiche - 1	
	33	6	0	PdC ore di funz. (h/10)	
	33	6	1	Ore di funz resistenza 1 (h/10)	
	33	6	2	Ore di funz resistenza 2 (h/10)	
	33	6	3	PdC n. cicli Accensione (n/10)	
	33	6	4	Cicli resistenza 1 (n/10)	
	33	6	5	Cicli resistenza 2 (n/10)	
	33	6	6	Tempo vita (h /10)	
	33	7		Statistiche - 2	
	33	7	1	Docce disponibili	
	33	7	3	Tempo di riscaldamento rimanente	
	33	8		Diagnostica Pompa Calore - 1	
SET	33	8	0	Temperatura interna	
	33	8	1	Temperatura desiderata	
P23	33	8	2	Temperatura duomo	
P22	33	8	3	Sonda di temperatura alta	
P21	33	8	4	Sonda di temperatura bassa	
	33	9		Diagnostica Pompa Calore - 2	
P24	33	9	0	Temperatura esterna	
P25	33	9	1	Temp evaporatore	
P26	33	9	2	Temp aspirazione compr.	
P28	33	9	3	Temp mandata compr.	
P27	33	9	4	Temp del refrigerante	
P29	33	9	5	Temperatura surriscaldamento	
	33	10		Diagnostica Pompa Calore - 3	
ICONE DISPLAY	33	10	0	Stato	0. Blocco 1. Idle 2. Riscaldamento 3. Ciclo di sanificazione termica 4. Antigelo
HP 	33	10	1	Modalità Operative	0. Non definito 1. Idle 2. Pre ventilazione 3. Riscaldamento 4. Post ventilazione 5. Sbrinamento 6. Sbrinamento 7. Temperatura aria fuori range 8. Modalità ricarica

MENU HPWH	MENU	SOTTO-MENU	PARAMETRO	DESCRIZIONE	RANGE
	33	10	2	Modalità di riscaldamento	1. OFF 2. Pompa di calore 3. Modalità SG 4. PDC + Resistenza 1 5. Resistenza 1 + Resistenza 2 6. Resistenza 2 7. PDC + Resistenza 2 8. Auxiliary 9. PDC + AUX
					
	33	11		Diagnostica Pompa Calore - 4	
	33	11	0	Frequenza attuale compressore	
	33	11	1	Velocità Ventil	
	33	11	2	Valvola di espansione	
	33	11	3	HC - HP input	OFF - ON
	33	11	4	PV - SG input	OFF - ON
	33	12		Storico errori	
P30	33	12	0	Ultimi 10 errori	
P30	33	12	1	Reset lista errori	Vuoi realmente eseguire il reset ? Se premi OK il comando di reset verrà eseguito, altrimenti premendo ESC torni alla pagina precedente
					33
P18	33	13	0	Ripristino Impost di Fabbrica	Vuoi realmente eseguire il reset ? Se premi OK il comando di reset verrà eseguito, altrimenti premendo ESC torni alla pagina precedente
					U9

CONTROL REMOTO

(Software version 07.04.07)

1. botón atrás  (visualización anterior)
2. botón
3. botón **OK** (confirmar la operación o entrar en el menú principal)
4. DISPLAY

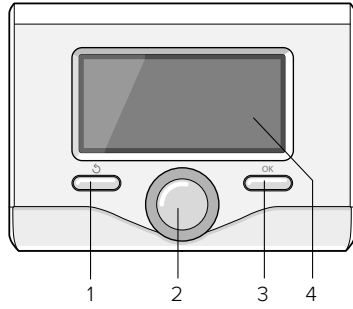

MENÚ DE USUARIO

Presionar la tecla OK para entrar en el menú. Utilizar el botón central para pasar la lista del menú y la selección de los parámetros, presionar la tecla OK para confirmar.



MODOS DE OPERACIÓN DEL SISTEMA	
Verano	OFF
MENÚ	
AJUSTES AGUA CALIENTE	
Temperatura confort agua caliente	
Programación horaria	
Sanitario	
- Ajustes temp. confort	
- Ajustes temp. reducida	
- Ajustes programación	
- Sanitario Pre-heating	
Timer auxiliar	
- Ajustes temp. confort	
Confort activo/desactivado	
- Desactivada	
- Temporizada	
- Siempre activa	
Función antilegionela	
- Función antilegionela	
- T° disinfección térmica deseada	
Modo operación	
- Green	
- Comfort	
- Fast	
- I-memory	
- Horas pico - horas valle	
Función boost para agua caliente	
- OFF	
- ON	
Función vacaciones	
- OFF	
- ON	
FUNCIONES ESPECIALES	
Activación modo silencio HPWH	
- OFF	
- ON	
Delta temp. setpoint sanit. fotovoltaico	
PRESTACIONES SISTEMAS	
Contador de energía	
Historico de consumos	
- Sanitario	
DHW temperature (T dome) (non disponibile)	

ÁREA TÉCNICA

- Presionar al mismo tiempo los botones atrás  y "OK" hasta que el display muestre "Inserción código".
- Girar el botón para introducir el código técnico (234), presionar la tecla OK, el display visualiza **ÁREA TÉCNICA**.
- Girar el botón y seleccionar: **MENÚ COMPLETO**. Presionar la tecla OK. Girar el botón y seleccionar el menú **33 HPWH Parameters**, presionar la tecla OK.

MENÚ HPWH	MENÚ	SUB-MENÚ	PARÁMETRO	DESCRIPCIÓN	RANGO
	33			Parámetros HPWH	
	33	0		Parámetros usuarios	
MODE	33	0	0	Modo operación	0. Green 1. Comfort 2. Fast 3. I-memory 4. Horas pico - horas valle
P16 U8	33	0	1	Modo silencio	OFF - ON
P15	33	0	2	Tono de respuesta toque	OFF - ON
>>	33	0	3	Función boost para agua caliente	OFF - ON
U3.2	33	0	4	ACS precalentamiento	OFF - ON
	33	1		Config.Avanzada	
P10	33	1	0	Capacidad acumulador	
P6	33	1	1	Temperatura confort i - memory	
P8	33	1	2	Min temp. aire BC	
P7	33	1	3	Max temp. BC	
P9	33	1	4	Hist temp. BC	
	33	2		Configuración entrada salida	
P1	33	2	0	Modo HC - HP	0. OFF 1. Horas pico - horas valle 2. Horas pico - horas valle - 40 3. HC - Bomba de calor 24h
P11	33	2	1	Integración fotovoltaico	0. OFF 1. Bomba de calor 2. Bomba de calor + HE1 3. Bomba de calor + HE1 + HE2
P12	33	2	2	Temperatura de consigna PV	
P13	33	2	3	Mode SG	OFF - ON
	33	3		Configuración sistema	
P14	33	3	0	Esquema hidráulico	0. Bomba de calor sola 1. Auxiliar 2. Precalentador 3. Sistema Bomba de calor
	33	4		Sanitario	
+ / -	33	4	0	Temperatura confort agua caliente	
U3.1	33	4	1	Temperatura reducida agua caliente	
P4	33	4	2	Temp Máx	

MENU HPWH	MENÚ	SUB-MENÚ	PARÁMETRO	DESCRIPCIÓN	RANGO
P5	33	4	3	Temp Mín	
U1	33	4	4	Función confort	0. Desactivada 1. Temporizado 2. Siempre activa
P1	33	4	5	Max tiempo de calentamiento	
P2 U5	33	4	6	Función antilegionela	OFF - ON
P3	33	4	7	T° disinfección térmica deseada	
	33	6		Estadísticas - 1	
	33	6	0	Horas func. BC (h/10)	
	33	6	1	Horas de trabajo de la res. 1 (h/10)	
	33	6	2	Horas de trabajo de la res. 2 (h/10)	
	33	6	3	Número de arranques BdC (n/10)	
	33	6	4	Ciclos de la resistencia 1 (n°/10)	
	33	6	5	Ciclos de la resistencia 2 (n°/10)	
	33	6	6	Tiempo de funcion. (h /10)	
	33	7		Estadísticas - 2	
	33	7	1	Número de duchas	
	33	7	3	Calentamiento para ajustar Temp Tiempo restante	
	33	8		Diagnóstico B.C. - 1	
SET	33	8	0	Temperatura interna	
	33	8	1	Temperatura deseada	
P23	33	8	2	Medio temp	
P22	33	8	3	Temperatura sonda superior	
P21	33	8	4	Temperatura sonda inferior	
	33	9		Diagnóstico B.C. - 2	
P24	33	9	0	Temperatura externa	
P25	33	9	1	Temperatura evaporación B.C.	
P26	33	9	2	Temperatura aspiración B.C.	
P28	33	9	3	Temp. entrada compresor B.C.	
P27	33	9	4	Temperatura salida compresor B.C.	
P29	33	9	5	Temperatura de recalentamiento	
	33	10		Diagnóstico B.C. - 3	
ICONE DISPLAY	33	10	0	Estado	0. Desbloqueo 1. Libre 2. Calefacción 3. Función antilegionela 4. Antihielo
HP 	33	10	1	Modo bomba de calor	0. No definido 1. Libre 2. Pre ventilador 3. Calefacción 4. Post ventilador 5. Descongelación 6. Descongelación 7. Temperatura del aire fuera de rango 8. Modo carga

MENU HPWH	MENÚ	SUB-MENÚ	PARÁMETRO	DESCRIPCIÓN	RANGO
HP 	33	10	2	Estado de carga	1. OFF 2. Bomba de calor 3. HE1 4. Bomba de calor + HE1 5. HE1 + HE2 6. HE2 7. Bomba de calor + HE2 8. Auxiliary 9. Bomba de calor + AUX
	33	10	3	Integración PV activa	OFF - ON
	33	10	4	SG activo	OFF - ON
	33	11		Diagnóstico B.C. - 4	
	33	11	0	Frecuencia compresor B.C.	
	33	11	1	Velocidad Ventilador	
	33	11	2	Válvula de expansión	
	33	11	3	HC - Bomba de calor input	OFF - ON
	33	11	4	PV - SG input	OFF - ON
	33	12		Historico de defectos	
P30	33	12	0	10 últimos defectos	
P30	33	12	1	Reiniciar listado defectos	Quiere activar el reinicio ? Si aprieta OK, se valida el reinicio. Si aprieta ESC, se vuelve a la pantalla anterior
	33	13		Menu reinicio	
P18	33	13	0	Volver a los ajustes de fabrica	Quiere activar el reinicio ? Si aprieta OK, se valida el reinicio. Si aprieta ESC, se vuelve a la pantalla anterior
U9	33	13	1	Resetear i - memory	Quiere activar el reinicio ? Si aprieta OK, se valida el reinicio. Si aprieta ESC, se vuelve a la pantalla anterior

BEDIENEINHEIT

(Softwareversion 07.04.07)

1. Taste „Zurück“  (vorherige Anzeige)
2. Drehknopf
3. **OK** -Taste (Funktion bestätigen oder Gesamtmenü aufrufen)
4. DISPLAY

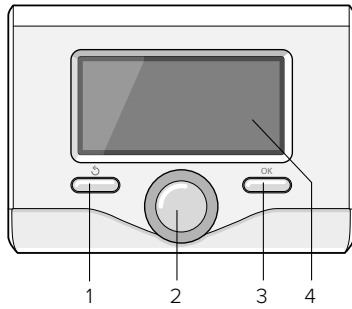

BENUTZERMENÜ

OK drücken, um in das Menü zu gelangen.



Den Knopf in der Mitte drücken, um durch die Menü-Liste zu blättern und einen Parameter auszuwählen, dann OK zum Bestätigen drücken.



SYSTEM-BETRIEBSARTEN	
	Sommer (nur Brauchwasser) AUS
GESAMTMENÜ	
WARMWASSEREINSTELLUNG	
Warmwasser-Solltemperatur	
Uhrzeitprogramme	
Warmwasser	
- Einstellung T Komfort	
- Einstellung T reduziert	
- Zeitprogramme erstellen	
- Warmwasser Pre-heating	
Hilfsprogramme	
- Einstellung T Komfort	
Komfort Funktion	
- Deaktiviert	
- Zeitbasiert	
- Ständiger betrieb	
Legionellenschutz funktion	
- Legionellenschutz funktion	
- Legionellenschutz Solltemperatur	
Betriebsmodus	
- Green	
- Komfort	
- Schnell	
- I-memory	
- Heizen WP	
Warmwasser Schnellladung (boost)	
- AUS	
- EIN	
Ferien Funktion	
- AUS	
- EIN	
SPEZIAL BETRIEBSARTEN	
Aktivierung Leiser Betrieb HPWH	
- AUS	
- EIN	
PV: Warmwasser solltemp erhöhung	
SYSTEMLEISTUNG	
Energieverbrauch	
Verbrauchsentwicklung	
- Warmwasser	
DHW temperature (T dome) (non disponibile)	

TECHNISCHEN BEREICH

- Drücken Sie gleichzeitig die Zurück-Taste  und dieOK“-Taste, bis „Code eingeben“ auf dem Display erscheint.
- Drehen Sie den Knopf, um den technischen Code (234) einzugeben und drücken Sie OK. Das Display zeigt: **FACHMANNBEREICH**
- Den Knopf drehen und auswählen: **GESAMTMENÜ**. Zum Bestätigen OK drücken. Den Knopf drehen und auswählen: **33 HPWH Parameters**, Zum Bestätigen OK drücken.

MENU HPWH	MENÜ	UNTERMENÜ	PARAMETER	BESCHREIBUNG	RANGE
	33			HPWH parameter	
	33	0		Benutzer parameter	
MODE	33	0	0	Betriebsmodus	0. Green 1. Komfort 2. Schnell 3. I-memory 4. Heizen WP
P16 U8	33	0	1	Leiser betrieb	AUS - EIN
P15	33	0	2	Akustische berührung rückmeldung	AUS - EIN
>>	33	0	3	Warm water boost	AUS - EIN
U3.2	33	0	4	Warmwasser vorewärmung	AUS - EIN
	33	1		Erweiterte einstellungen	
P10	33	1	0	Speicherinhalt	
P6	33	1	1	Komforttemperatur i - memory	
P8	33	1	2	Min lufttemperatur WP	
P7	33	1	3	Max temperatur WP	
P9	33	1	4	Hysteresetemperatur WP	
	33	2		Eingang ausgang konfiguration	
P1	33	2	0	Modus HK - WP	0. AUS 1. Heizen WP 2. Heizen WP 40 3. HK - WP 24h
P11	33	2	1	Einbindung photovoltaik	0. AUS 1. Wärmepumpe 2. WP + HE1 3. HP + HE1 + HE2
P12	33	2	2	PV Solltemperatur	
P13	33	2	3	Mode SG	AUS - EIN
	33	3		Einstellungen anlage	
P14	33	3	0	Hydraulikschema	0. Nur Wärmepumpe 1. Hilfs 2. Vorwärmer 3. Wärmepumpe System
	33	4		Warmwassererzeugung	
+ / -	33	4	0	Warmwasser-Solltemperatur	
U3.1	33	4	1	Warmwasser reduzierte Temperatur	
P4	33	4	2	Max. Temp	
P5	33	4	3	Min. Temp	
U1	33	4	4	Komfort Funktion	0. Deaktiviert 1. Zeitbasiert 2. Ständiger betrieb
P1	33	4	5	Max heizzeit	

MENU HPWH	MENÜ	UNTERMENÜ	PARAMETER	BESCHREIBUNG	RANGE
P2 U5	33	4	6	Legionellenschutz funktion	AUS - EIN
P3	33	4	7	Legionellenschutz Solltemperatur	
	33	6		Statistiken - 1	
	33	6	0	WP-betriebsstunden (h/10)	
	33	6	1	Elektroeingang stufe 1 stunden (h/10)	
	33	6	2	Elektroeingang stufe 2 stunden (h/10)	
	33	6	3	WP anzahl on - zyklen (n/10)	
	33	6	4	Elektroeingang stufe 1 zyklen (n/10)	
	33	6	5	Elektroeingang stufe 2 zyklen (n/10)	
	33	6	6	Betriebsstunden (h /10)	
	33	7		Statistiken - 2	
	33	7	1	verfügbare Duschen	
	33	7	3	Restzeit erhitzen	
	33	8		WP Diagonse - 1	
SET	33	8	0	Innentemperatur	
	33	8	1	Gewünschte Temperatur	
P23	33	8	2	Temperatur der Kuppel	
P22	33	8	3	Hohe Sensortemperatur	
P21	33	8	4	Niedrige Sensortemperatur	
	33	9		WP Diagonse - 2	
P24	33	9	0	Außenluft-Temperatur	
P25	33	9	1	WP Verdampfer-Temperatur	
P26	33	9	2	WP Sauggast-Temperatur	
P28	33	9	3	WP Heisgast-Temperatur	
P27	33	9	4	WP Kondensator Ausgangstemperatur	
P29	33	9	5	Überhitzungstemperatur	
	33	10		WP Diagonse - 3	
ICONE DISPLAY	33	10	0	Status	0. Verriegelt 1. Wartet 2. Heizen 3. Legionellenschutz funktion 4. Antigelo
HP 	33	10	1	WP Betriebsmodus	0. Nicht definiert 1. Wartet 2. Vorlaufzeit Ventilator 3. Heizen 4. Nachlaufzeit Ventilator 5. Abtauung 6. Abtauung 7. Lufttemperatur außerhalb des zulässigen Bereichs 8. Betriebsart laden

MENU HPWH	MENÜ	UNTERMENÜ	PARAMETER	BESCHREIBUNG	RANGE					
HP 	33	10	2	Status heizen	1. AUS 2. Wärmepumpe 3. HE1 4. WP + HE1 5. HE1 + HE2 6. HE2 7. HP + HE2 8. AUX 9. HP+AUX					
						33	10	3	PV Einbindung Aktiv	AUS - EIN
						33	10	4	Eingang SG ready	AUS - EIN
					33	11		WP Diagonse - 4		
	33	11	0	WP Kompressor aktuelle Drehzahl						
	33	11	1	Gebläse Drehzahl						
	33	11	2	Expansionsventil						
	33	11	3	Eingang HC - HP	AUS - EIN					
	33	11	4	Eingang PV - SG	AUS - EIN					
	33	12		Fehlerhistorie						
P30	33	12	0	Letzte 10 Fehler						
P30	33	12	1	Reset Fehlerliste	Reset wirklich durchführen ? Durch Drücken der OK-Taste wird das Gerät zurückgesetzt. Mit der ESC-Taste gelangen Sie zurück zur vorherigen Seite.					
	33	13		Reset Menü						
P18	33	13	0	Reset Werkseinstellungen	Reset wirklich durchführen ? Durch Drücken der OK-Taste wird das Gerät zurückgesetzt. Mit der ESC-Taste gelangen Sie zurück zur vorherigen Seite.					
U9	33	13	1	Reset i - memory	Reset wirklich durchführen ? Durch Drücken der OK-Taste wird das Gerät zurückgesetzt. Mit der ESC-Taste gelangen Sie zurück zur vorherigen Seite.					

Bus BridgeNet® Schemes

HEAT PUMP WATER HEATER AND SEPARATE HEAT GENERATOR

EN: Heat pump water heater and dedicated boiler for heating only / FR: Chauffe-eau thermodynamique et chaudière dédiée au chauffage
 IT: Scaldacqua a pompa di calore e caldaia dedicata per il solo riscaldamento / ES: Bomba de calor para agua caliente sanitaria y caldera dedicada solo para la calefacción / DE: Warmwasser-Wärmepumpe und Boiler zum ausschließlichen Heizen

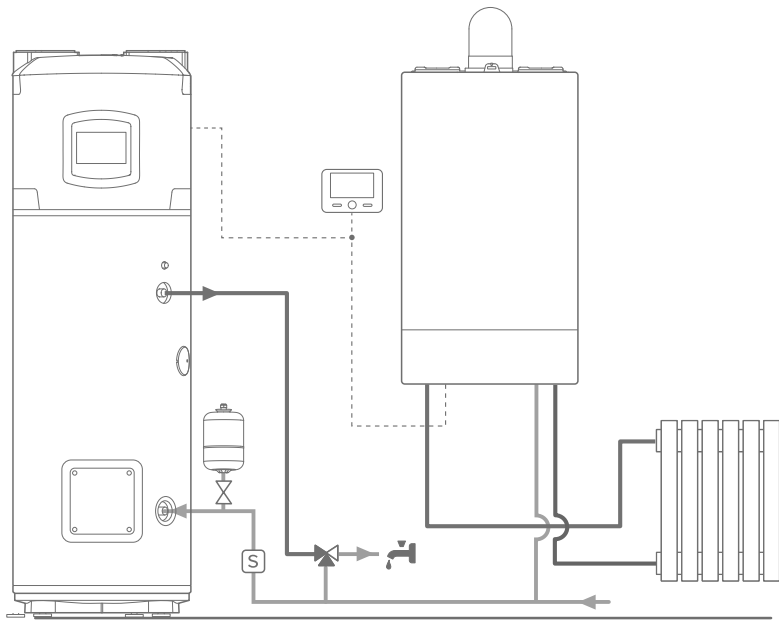

PRODUCT	PARAMETER	DESCRIPTION	VALUE
HPWH	33 3 0	Hydraulic scheme	0 (Only HP)
WHB	2 0 1	DHW preheating	0 (OFF)
	2 2 7	Boiler Hybrid	0 (Disabled)
	2 2 8	Boiler version	2 (Storage with Thermostat)

EN: Heat pump water heater and dedicated heat pump for heating only / FR: Chauffe-eau thermodynamique et pompe à chaleur dédiée au chauffage
 IT: Scaldacqua a pompa di calore e pompa di calore dedicata per il solo riscaldamento / ES: Bomba de calor para agua caliente sanitaria y bomba de calor dedicada solo para la calefacción / DE: Warmwasser-Wärmepumpe und spezielle Wärmepumpe zum ausschließlichen Heizen

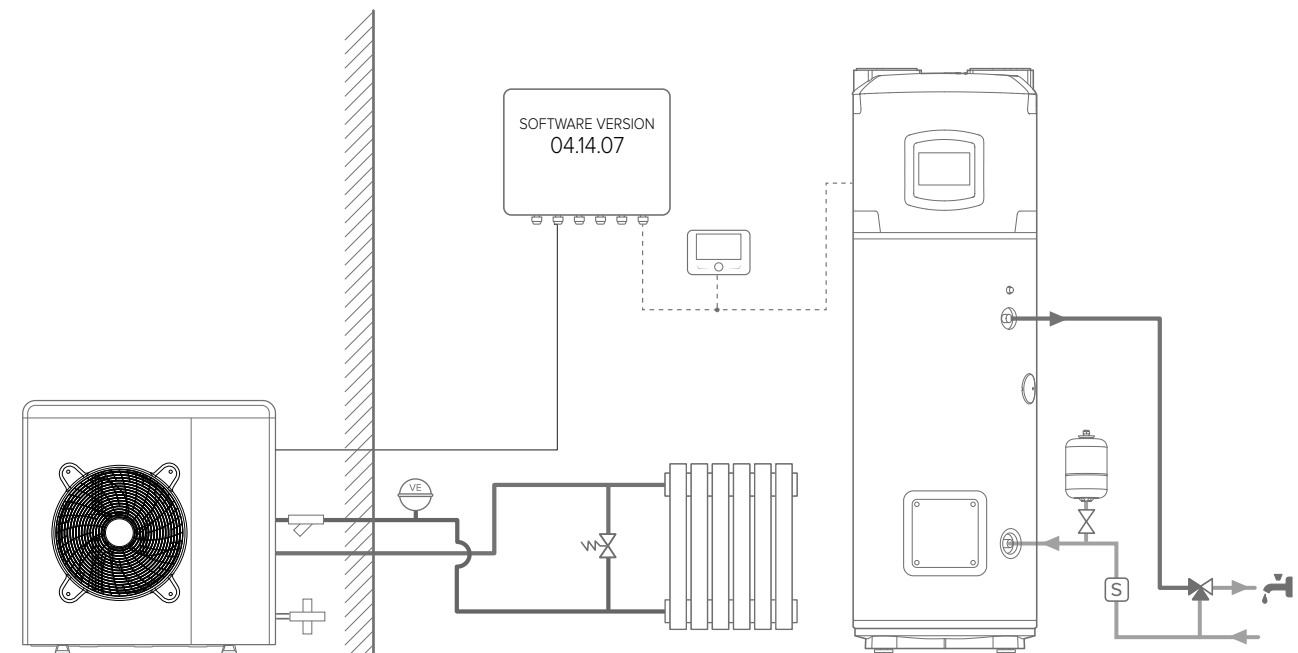

PRODUCT	PARAMETER	DESCRIPTION	VALUE
HPWH	33 3 0	Hydraulic scheme	0 (Only HP)
HHP	17 2 0	Hydraulic scheme	5 (Light)
	17 5 9	Light Box DHW Disable	1 (ON)

EN: Heat pump water heater and dedicated heat pump for heating only / FR: Chauffe-eau thermodynamique et pompe à chaleur dédiée au chauffage
 IT: Scaldacqua a pompa di calore e pompa di calore dedicata per il solo riscaldamento / ES: Bomba de calor para agua caliente sanitaria y bomba de calor dedicada solo para la calefacción / DE: Warmwasser-Wärmepumpe und spezielle Wärmepumpe zum ausschließlichen Heizen

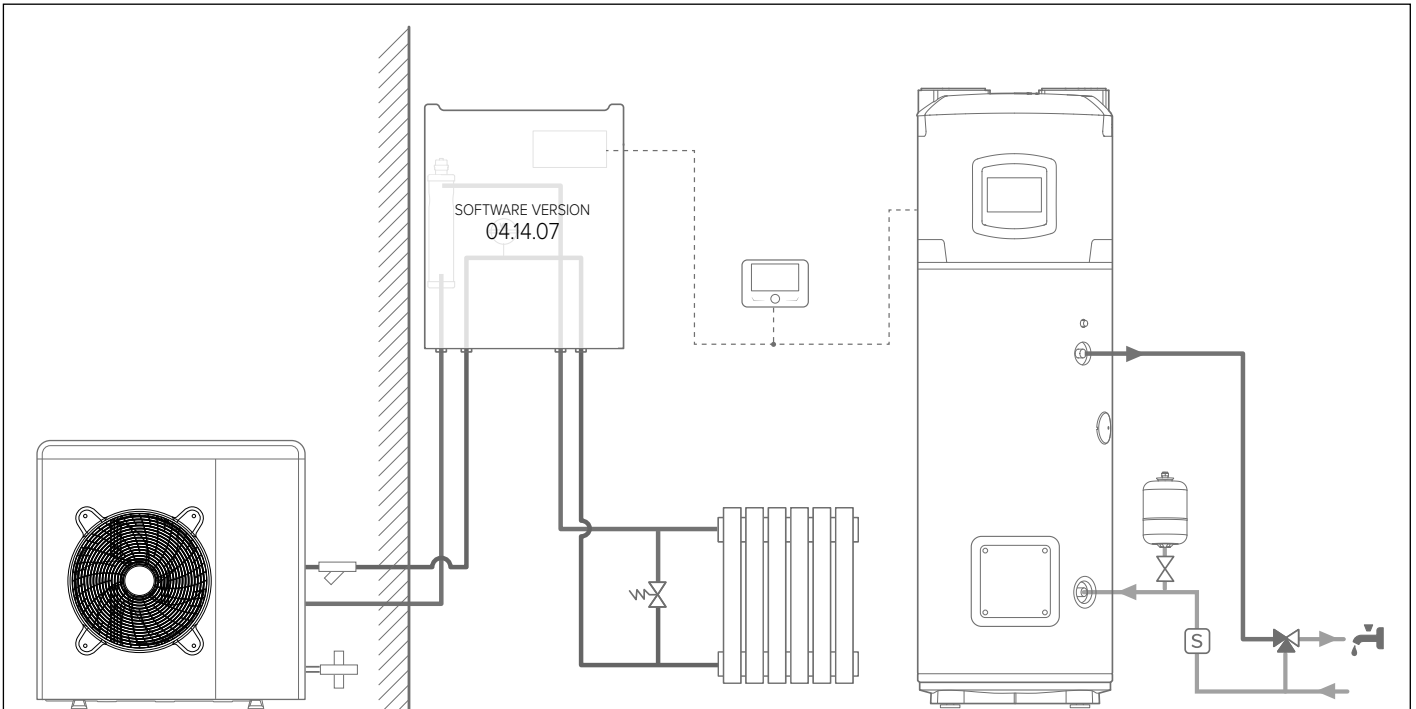

PRODUCT	PARAMETER	DESCRIPTION	VALUE
HPWH	33 3 0	Hydraulic scheme	0 (Only HP)
HHP	17 2 0	Hydraulic scheme	1 (Plus)
	17 5 9	Light Box DHW Disable	0 (Disabled)

EN: Heat pump water heater and hybrid system for heating only / FR: Chauffe-eau thermodynamique et système hybride dédié au chauffage
 IT: Scaldacqua a pompa di calore e sistema ibrido dedicato per il solo riscaldamento / ES: Bomba de calor para agua caliente sanitaria y sistema híbrido dedicado solo para la calefacción / DE: Warmwasser-Wärmepumpe und spezielles Hybridsystem zum ausschließlichen Heizen

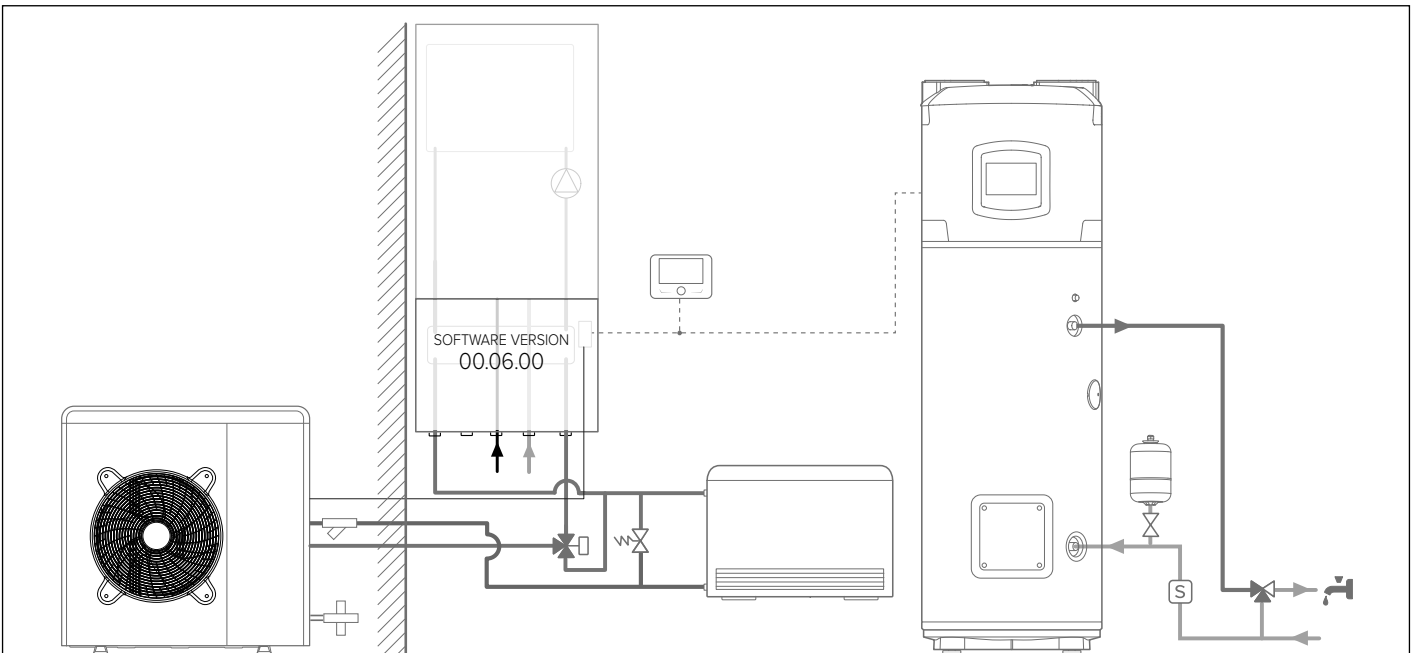

PRODUCT	PARAMETER	DESCRIPTION	VALUE
HPWH	33 3 0	Hydraulic scheme	0 (Only HP)
WHB	2 0 1	DHW preheating	0 (OFF)
	2 2 7	Boiler Hybrid	1 (Enable)
	2 2 8	Boiler version	2 (Storage with Thermostat)
HYB	12 2 0	Hydraulic scheme	2 (WHB + Tank)

HEAT PUMP WATER HEATER WITH AUXILIARY GENERATOR

EN: Heat pump water heater with boiler as auxiliary generator / FR: Chauffe-eau thermodynamique avec chaudière comme générateur auxiliaire
 IT: Scaldacqua a pompa di calore con caldaia come generatore ausiliario / ES: Bomba de calor para agua caliente sanitaria con caldera como generador auxiliar / DE: Warmwasser-Wärmepumpe mit Boiler als Hilfsgenerator.

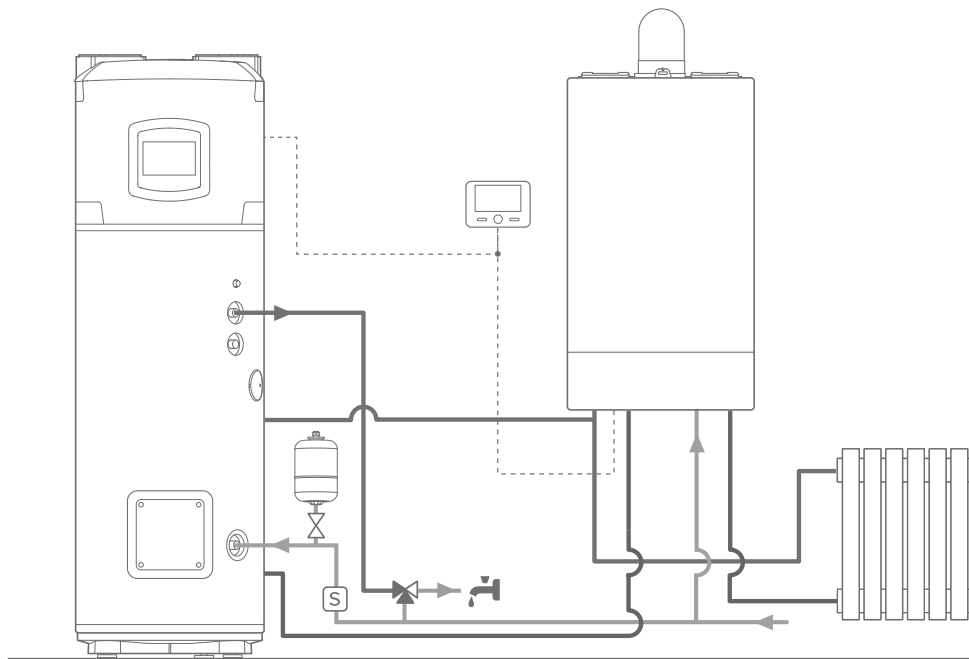

PRODUCT	PARAMETER	DESCRIPTION	VALUE
HPWH	33 3 0	Hydraulic scheme	3 (HP System)
WHB	2 0 1	DHW preheating	0 (OFF)
	2 2 7	Boiler Hybrid	0 (Disabled)
	2 2 8	Boiler version	2 (Storage with Thermostat)

EN: Heat pump water heater with solar thermal integration / FR: Chauffe-eau thermodynamique avec intégration solaire thermique
 IT: Scaldacqua a pompa di calore con integrazione solare termico / ES: Bomba de calor para agua caliente sanitaria con integración solar térmica
 DE: Warmwasser-Wärmepumpe mit integrierter Solarthermie.

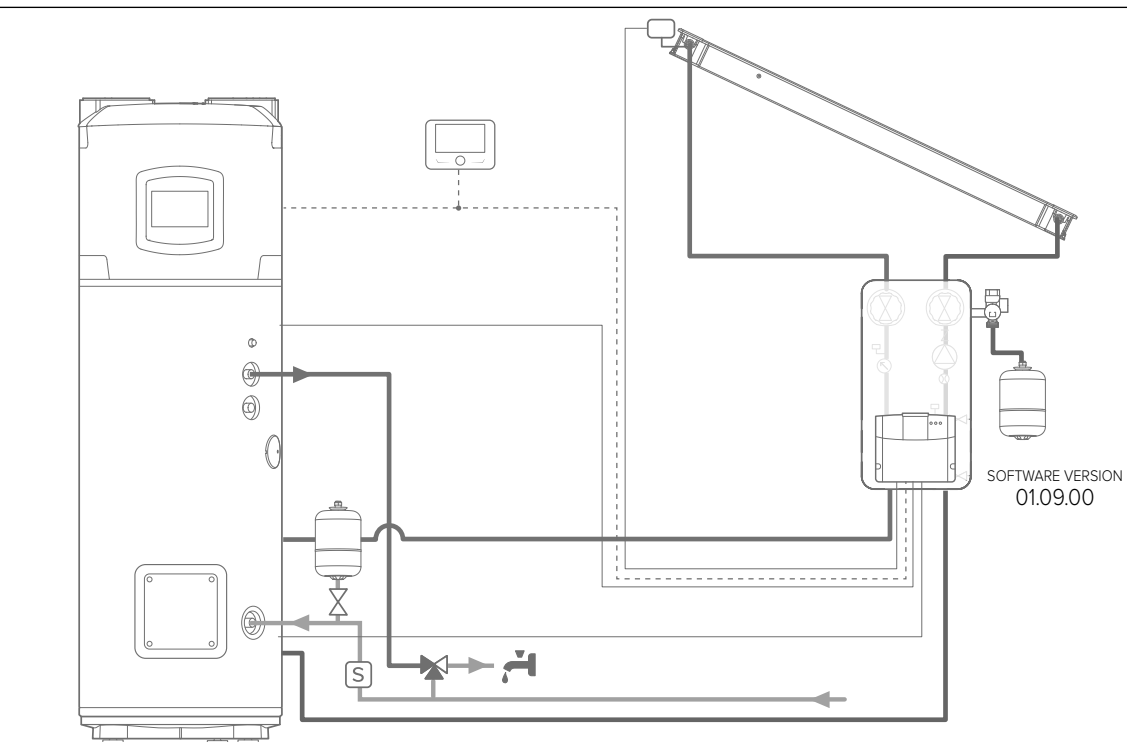

PRODUCT	PARAMETER	DESCRIPTION	VALUE
HPWH	33 3 0	Hydraulic scheme	0 (Only HP)
SM	3 2 1	Hydraulic scheme	1 (Basic single coil)

EN: Heat pump water heater with boiler as auxiliary generator and solar thermal integration.

FR: Chauffe-eau thermodynamique avec chaudière comme générateur auxiliaire et intégration solaire thermique

IT: Scaldacqua a pompa di calore con caldaia come generatore ausiliario e integrazione solare termico

ES: Bomba de calor para agua caliente sanitaria con caldera como generador auxiliar e integración solar térmica

DE: Warmwasser-Wärmepumpe mit Boiler als Hilfsgenerator und Solarthermie

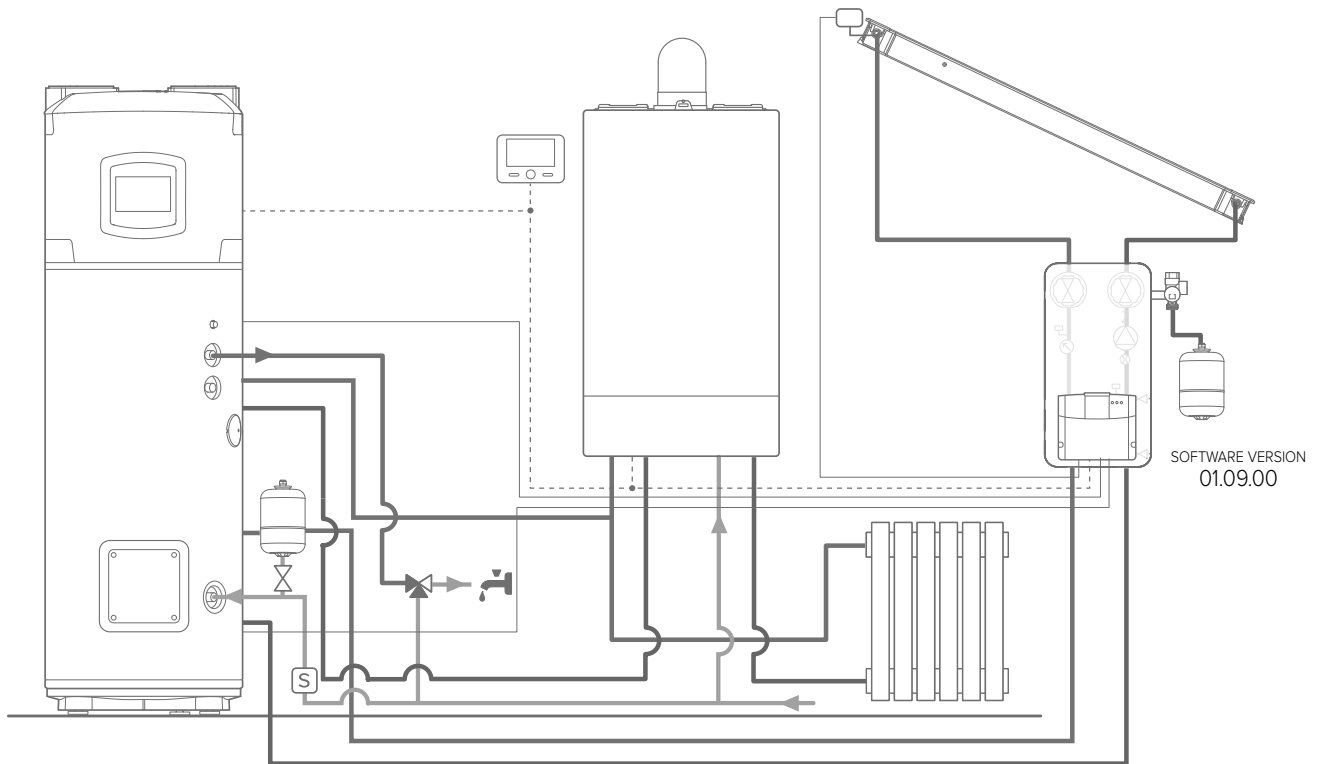

PRODUCT	PARAMETER	DESCRIPTION	VALUE
HPWH	33 3 0	Hydraulic scheme	3 (HP System)
WHB	2 0 1	DHW preheating	0 (OFF)
	2 2 7	Boiler Hybrid	0 (Disabled)
	2 2 8	Boiler version	2 (Storage with Thermostat)
SM	3 2 1	Hydraulic scheme	1 (Basic single coil)

HEAT PUMP WATER HEATER IN PRE-HEATING OF COMBINED HEATING GENERATOR

EN: Heat pump water heater in pre-heating of combined boiler. / FR: Chauffe-eau thermodynamique en préchauffage d'une chaudière mixte.

IT: Scaldacqua a pompa di calore in preriscaldamento di una caldaia combinata. / ES: Bomba de calor para agua caliente sanitaria en precalentamiento de una caldera mixta / DE: Warmwasser-Wärmepumpe beim Vorheizen eines Kombi-Boilers.

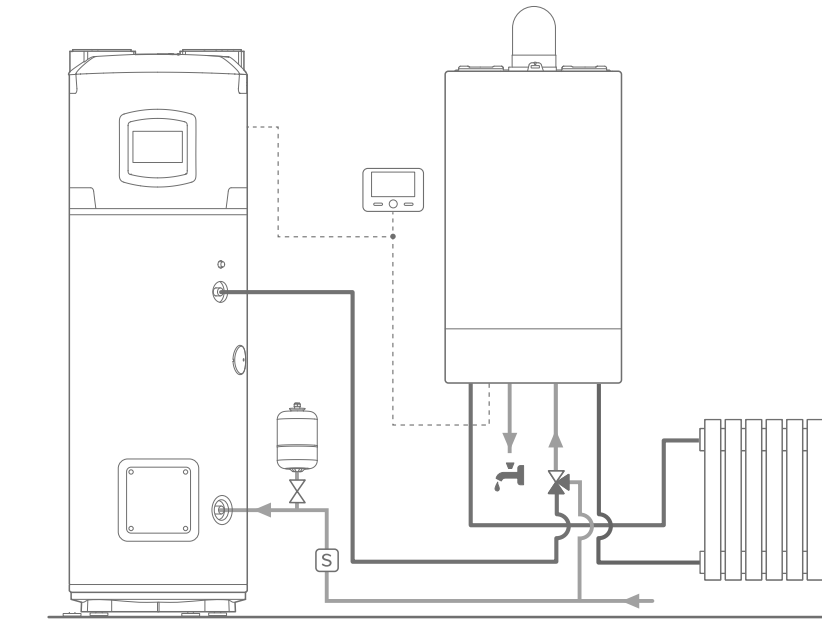

PRODUCT	PARAMETER	DESCRIPTION	VALUE
HPWH	33 3 0	Hydraulic scheme	2 (Preheater)
WHB	2 0 1	DHW preheating	0 (OFF)
	2 2 7	Boiler Hybrid	0 (Disabled)
	2 2 8	Boiler version	0 (Combi)

EN: Heat pump water heater in pre-heating of hybrid system / FR: Chauffe-eau thermodynamique en préchauffage d'un système hybride.

IT: Scaldacqua a pompa di calore in preriscaldamento di un sistema ibrido. ES: Bomba de calor para agua caliente sanitaria en precalentamiento de un sistema híbrido. / DE: Warmwasser-Wärmepumpe beim Vorheizen eines Hybridsystems.

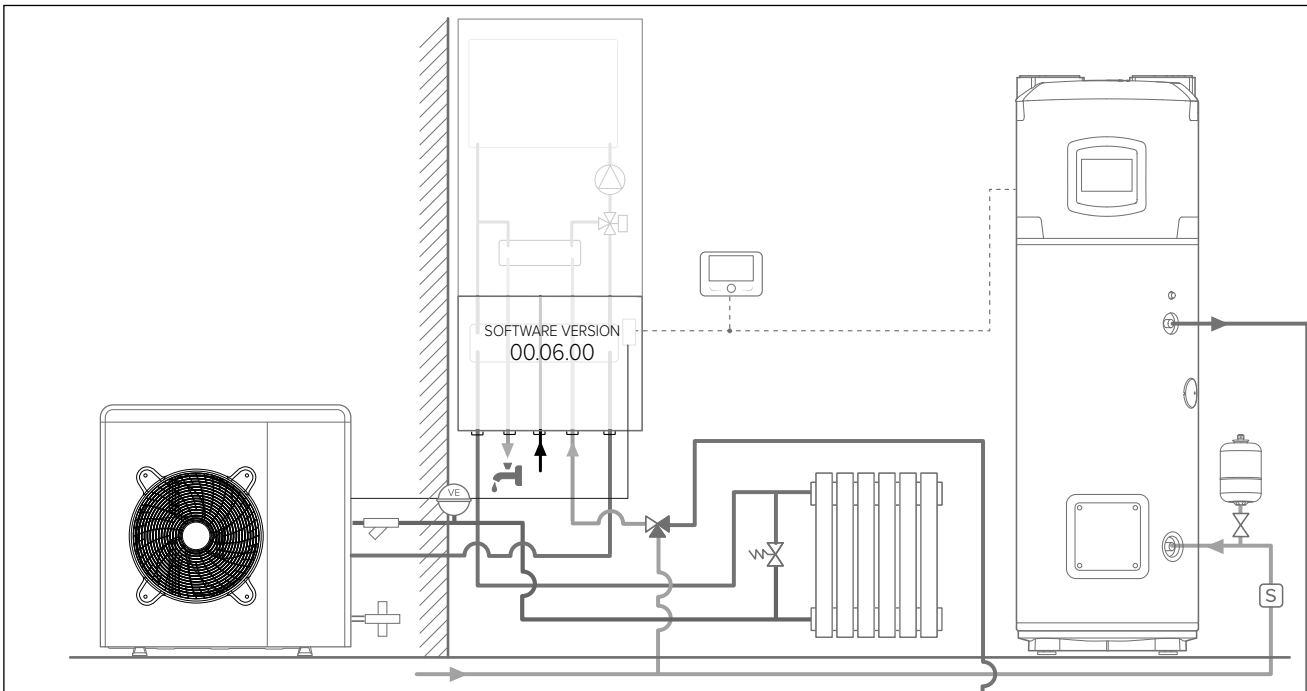

PRODUCT	PARAMETER	DESCRIPTION	VALUE
HPWH	33 3 0	Hydraulic scheme	2 (Preheater)
WHB	2 0 1	DHW preheating	0 (OFF)
	2 2 7	Boiler Hybrid	1 (Enable)
	2 2 8	Boiler version	0 (Combi)
HYB	12 2 0	Hydraulic scheme	1 (WHB Combi)



WARNING! / ATTENTION! / ATTENZIONE! / ¡ADVERTENCIA! / VORSICHT!

EN: THE HYDRAULIC SCHEMES SHOWN BELOW ARE NOT IN THE ADMITTED TYPES

FR: LES SCHÉMAS HYDRAULIQUES INDICUÉS CI-DESSOUS NE SONT PAS DANS LES TYPES ADMIS

IT: GLI SCHEMI IDRAULICI SOTTO RIPORTATI NON RIENTRANO NELLE TIPOLOGIE AMMESSE

ES: LOS ESQUEMAS HIDRÁULICOS QUE SE MUESTRAN A CONTINUACIÓN NO COINCIDEN CON LAS TIPOLOGÍAS ADMITIDAS

DE: DIE UNTEN ANGEZEIGTEN HYDRAULISCHEN SCHEMEN FALLEN NICHT MIT DEN ZUGELASSENEN TYPEN

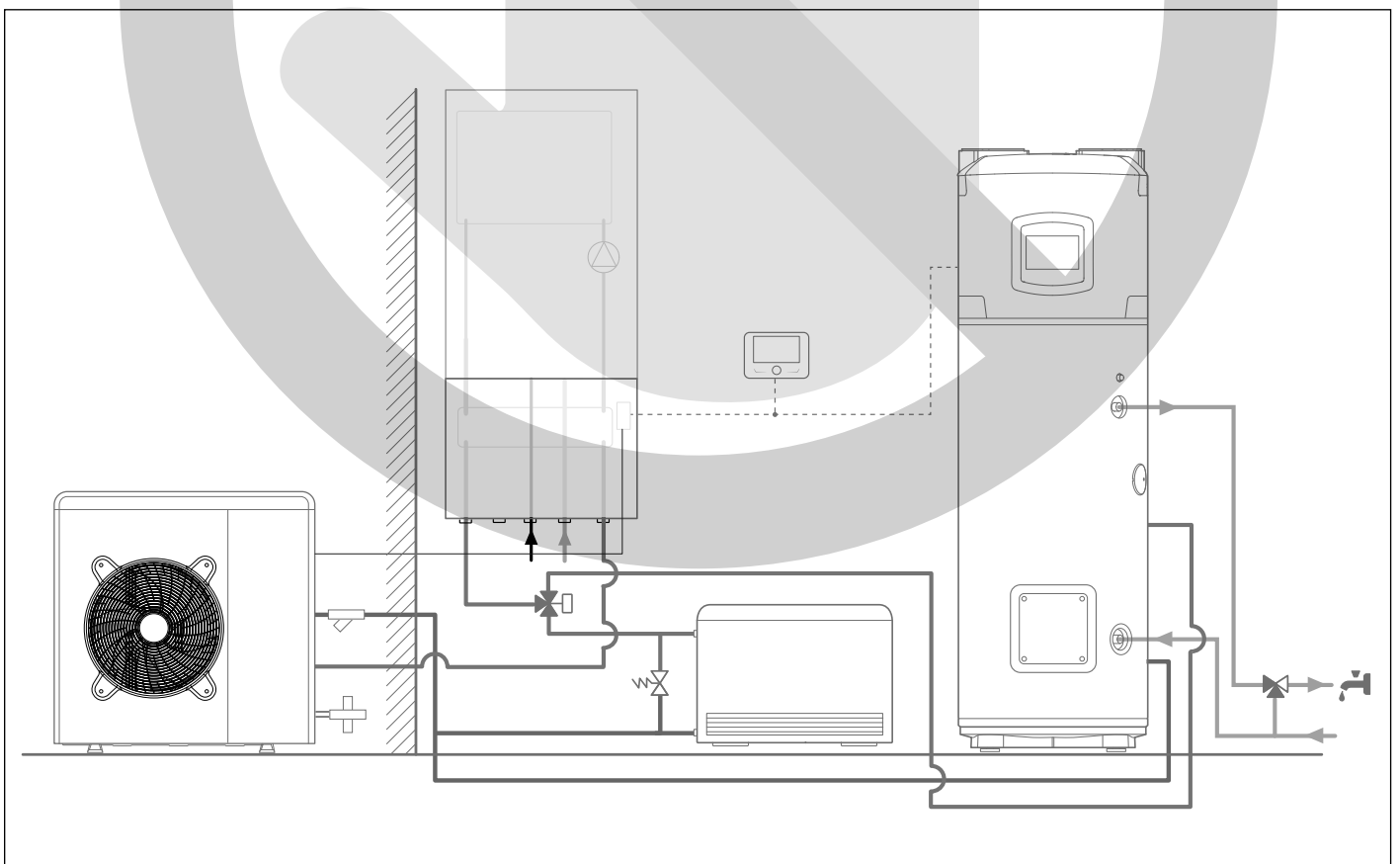
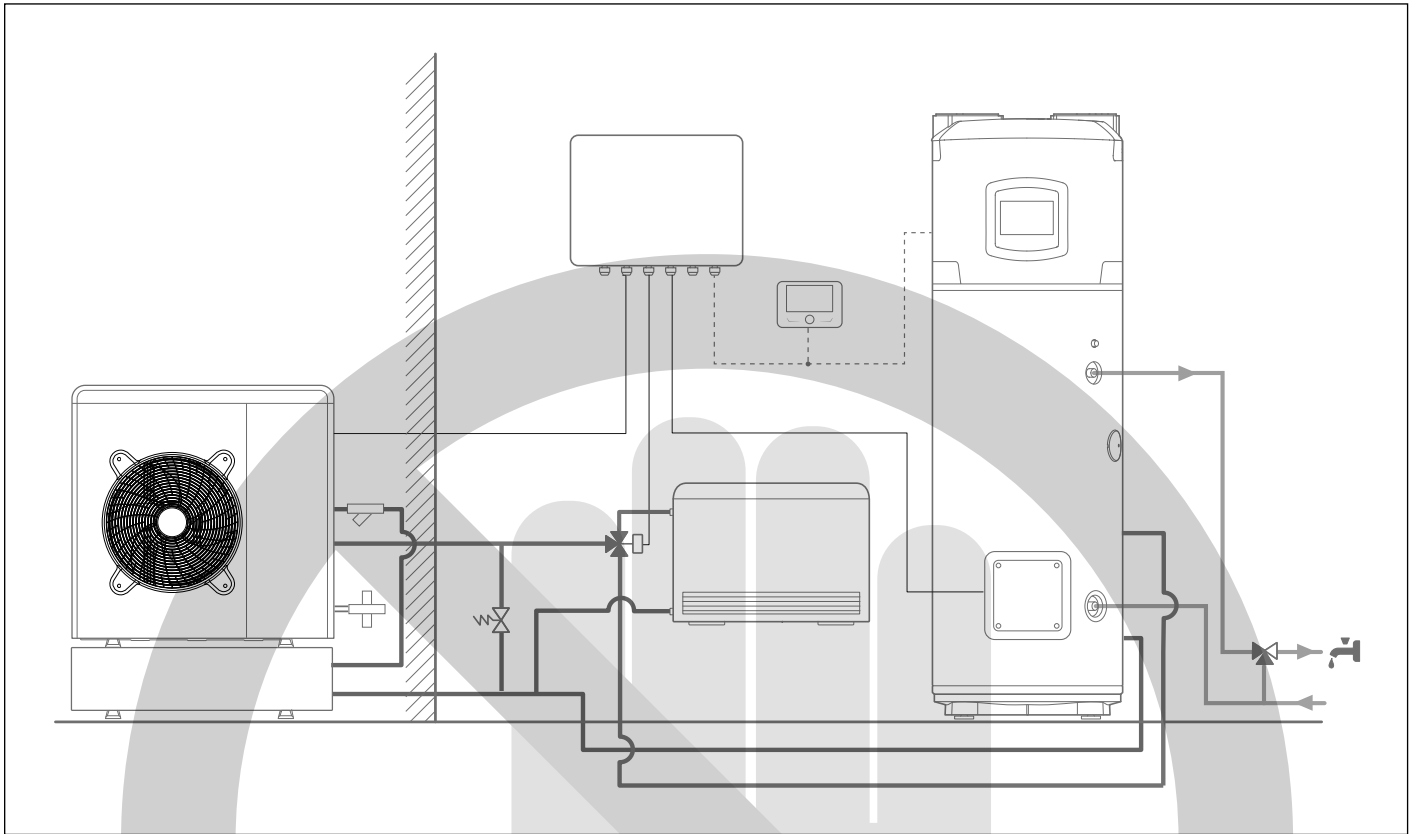

NOTE

- EN The schemes in this addendum are simplified and are intended to give general orientation on installation and configuration.
- FR Les schémas présentés sont simplifiés et sont destinés à donner une orientation générale sur l'installation et la configuration.
- IT Gli schemi riportati sono semplificati e hanno lo scopo di dare orientazioni generali su installazione e configurazione.
- ES Los esquemas presentados son simplificados y están destinados a dar orientación general sobre la instalación y configuración.
- DE Die dargestellten Diagramme sind vereinfacht und gelten als allgemeine Richtlinien für die Installation und Konfiguration.

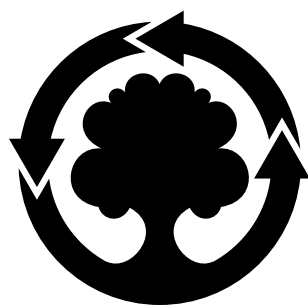

WE MAKE USE OF
RECYCLED PAPER

Ariston Thermo SpA

Viale Aristide Merloni, 45
60044 Fabriano (AN) Italy
Telefono 0732 6011
Fax 0732 602331
info.it@aristonthermo.com